

DIN0063

Eden Teak Bar Table 150x75

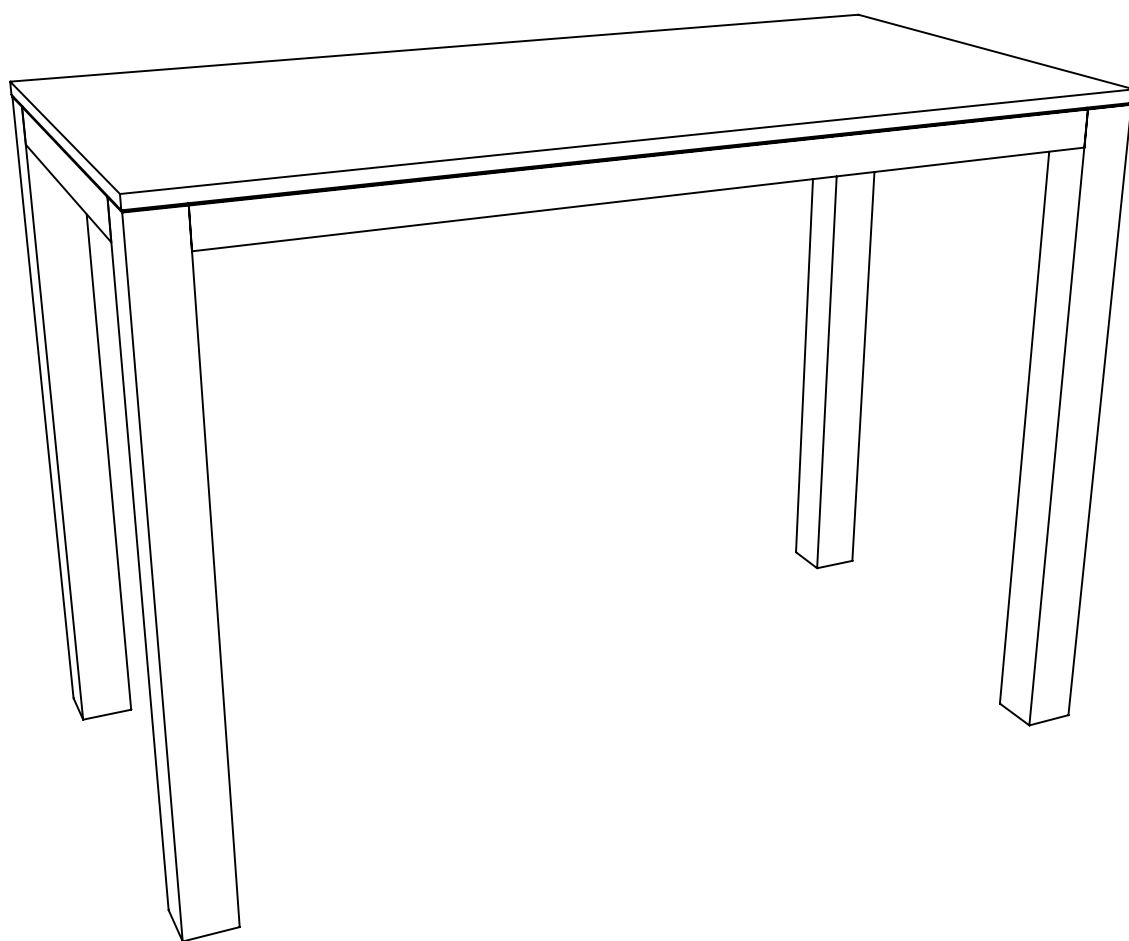

(FR) Notice de Montage -
Utilisation - Entretien

(IT) Istruzioni per il Montaggio,
l'Uso e la Manutenzione

(DE) Montage - Verwendung -
Wartungshandbuch

(ES) Instrucciones de Montaje,
Utilización y Mantenimiento

(EN) Assembly - Use -
Maintenance Manual

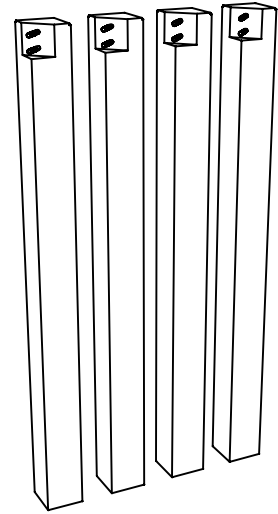
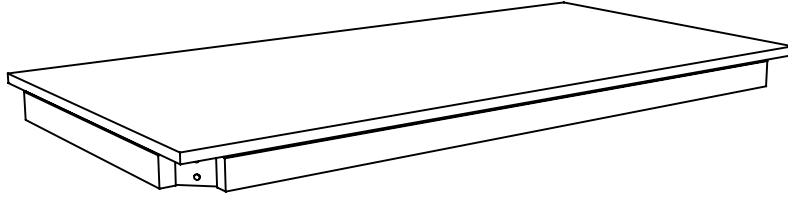
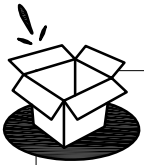

Plain Washer - M8

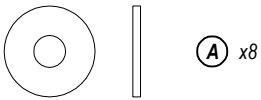

Plain Washer - M8

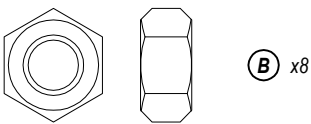

Spanner

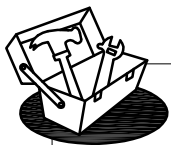
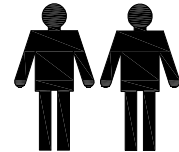
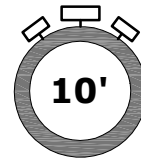
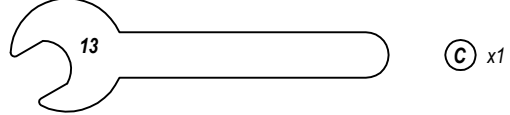

**NOT INCLUDED
NON FOURNIS**

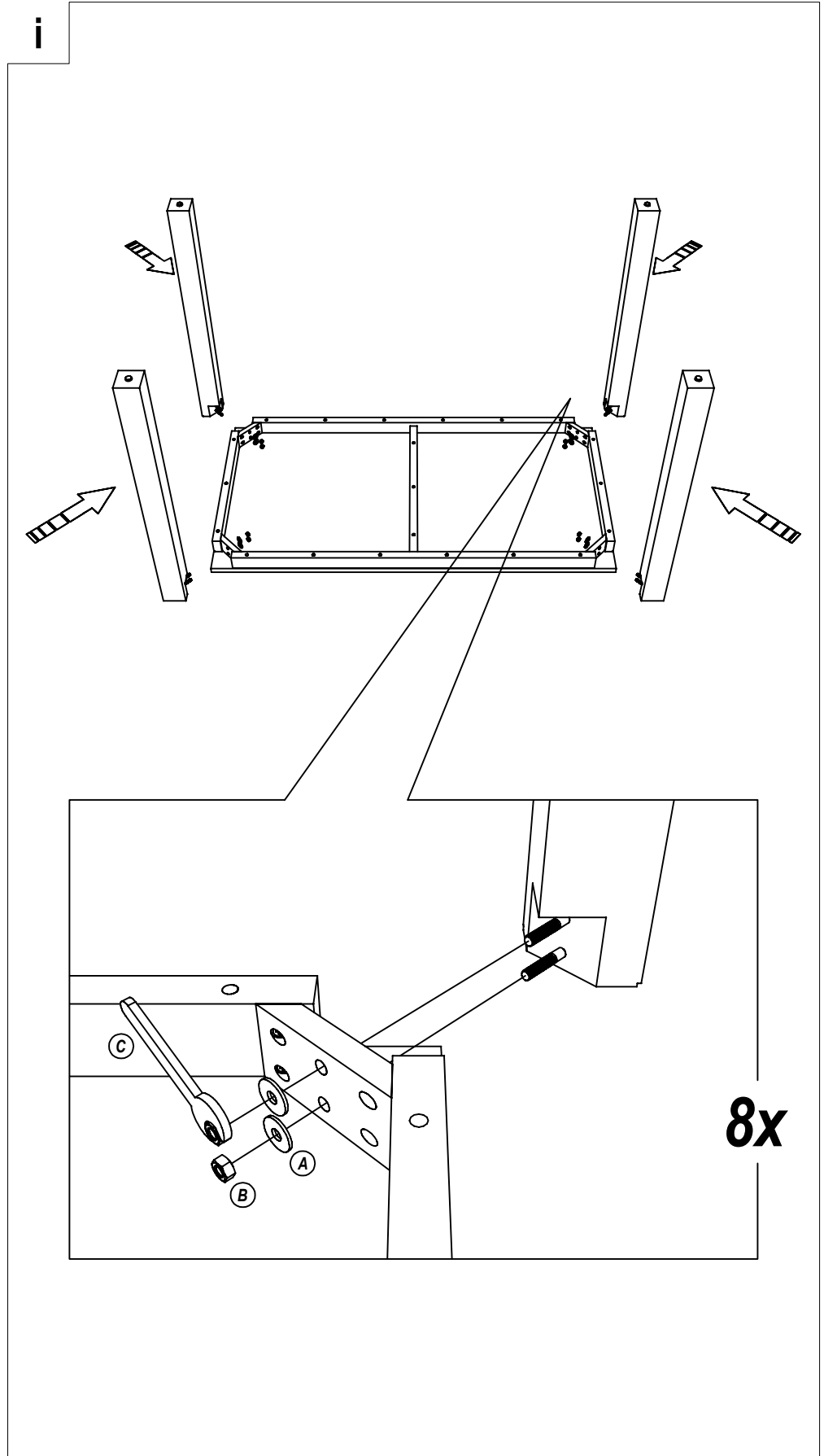
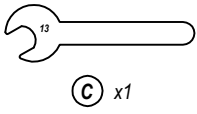
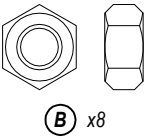
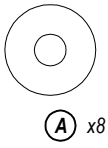

ii

