

DIN0062

Eden Teak Bar Table 120x60

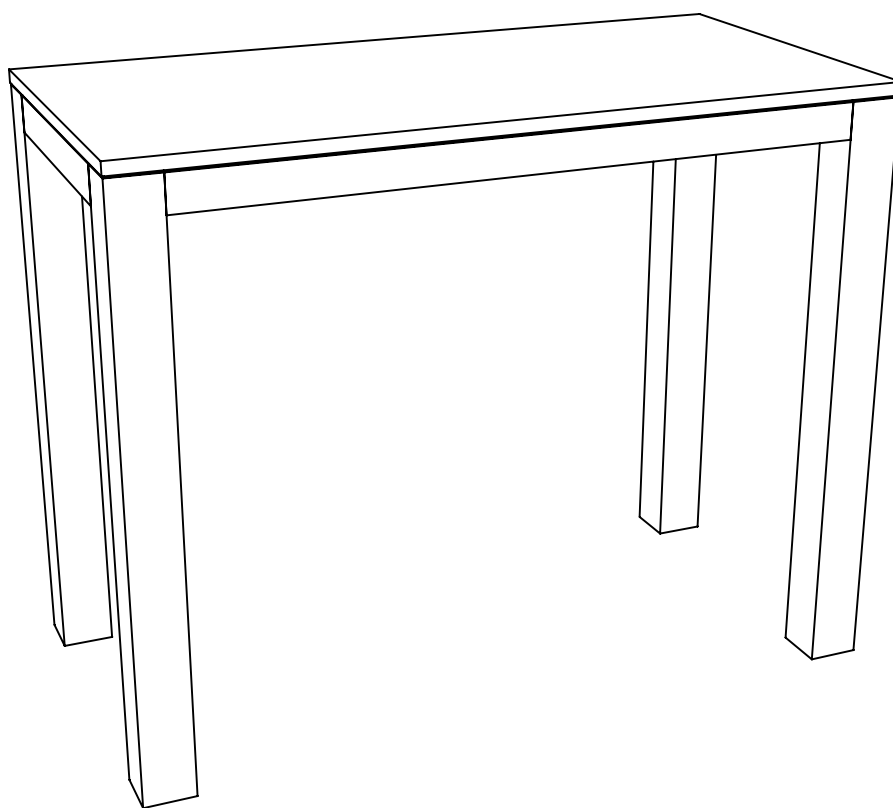

(FR) Notice de Montage -
Utilisation - Entretien

(IT) Istruzioni per il Montaggio,
l'Uso e la Manutenzione

(DE) Montage - Verwendung -
Wartungshandbuch

(ES) Instrucciones de Montaje,
Utilización y Mantenimiento

(EN) Assembly - Use -
Maintenance Manual

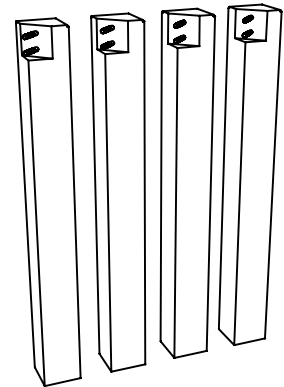
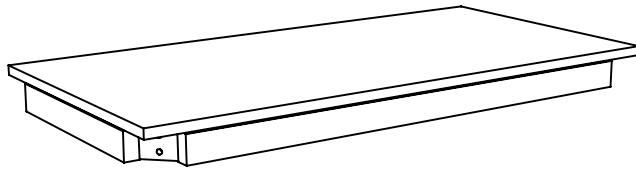
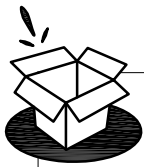

Plain Washer - M8

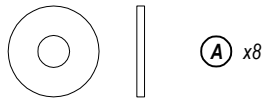

Spanner

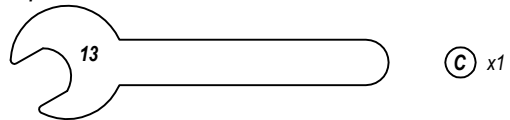

Plain Washer - M8

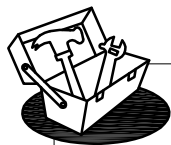
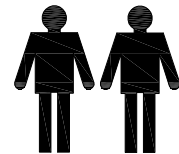
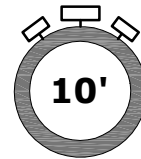
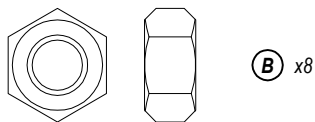

**NOT INCLUDED
NON FOURNIS**

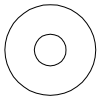

(A) x8

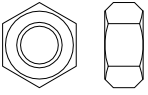

(B) x8

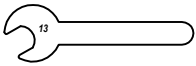

(C) x1

i

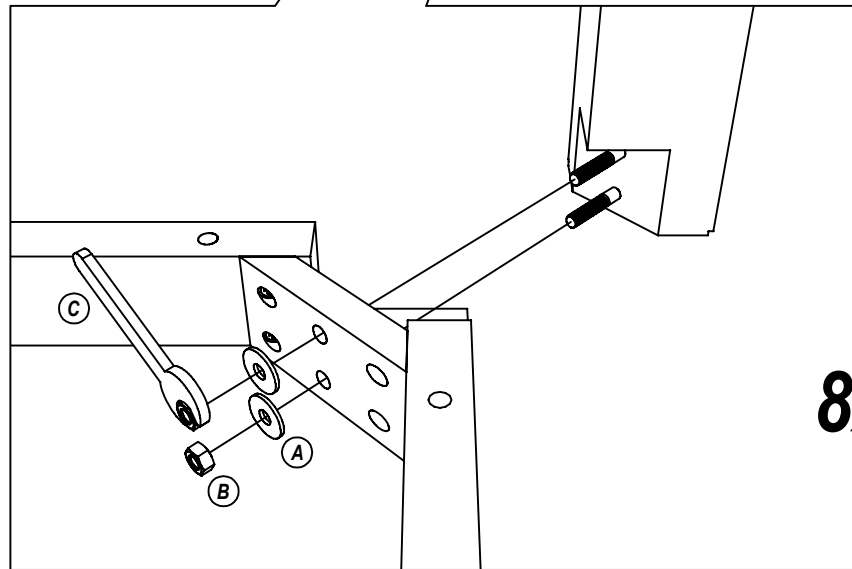
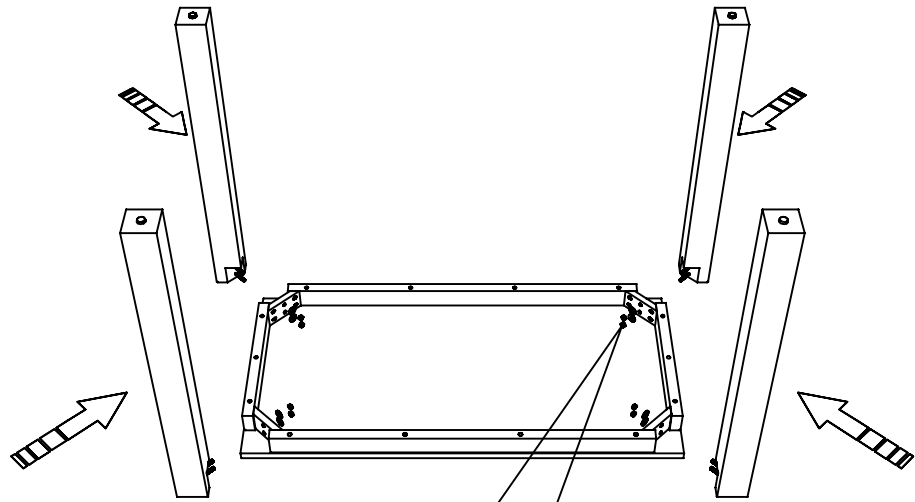

8x

ii

