

**DIN0060**

# Eden Teak Dining Table 125x125

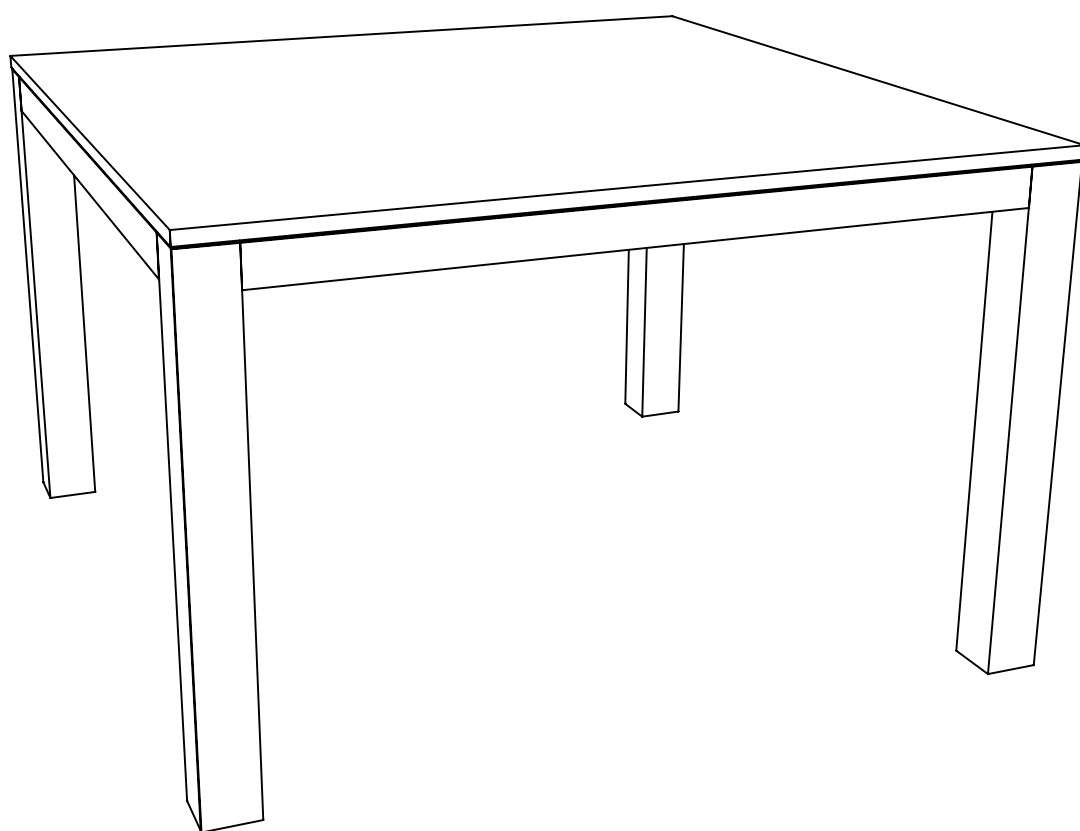

**(FR)** Notice de Montage -  
Utilisation - Entretien

**(IT)** Istruzioni per il Montaggio,  
l'Uso e la Manutenzione

**(DE)** Montage - Verwendung -  
Wartungshandbuch

**(ES)** Instrucciones de Montaje,  
Utilización y Mantenimiento

**(EN)** Assembly - Use -  
Maintenance Manual

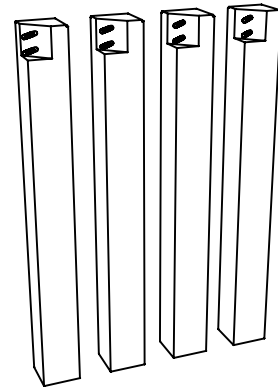
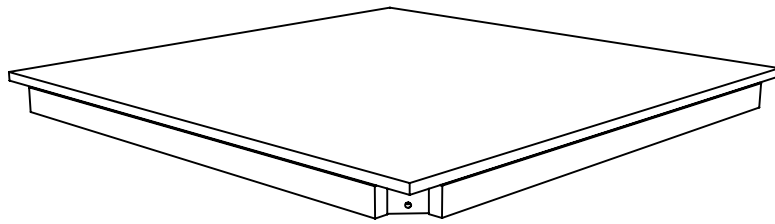

Plain Washer - M8

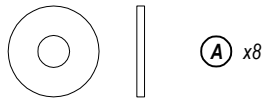

Spanner

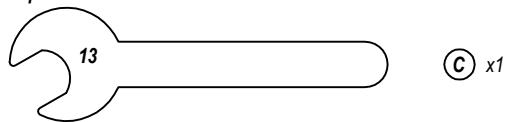

Plain Washer - M8

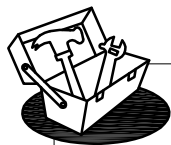
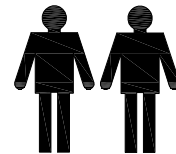
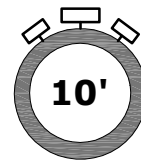
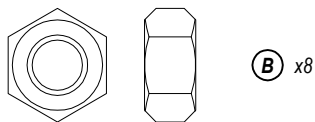

**NOT INCLUDED  
NON FOURNIS**

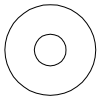

(A) x8

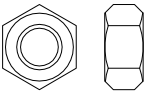

(B) x8

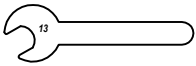

(C) x1

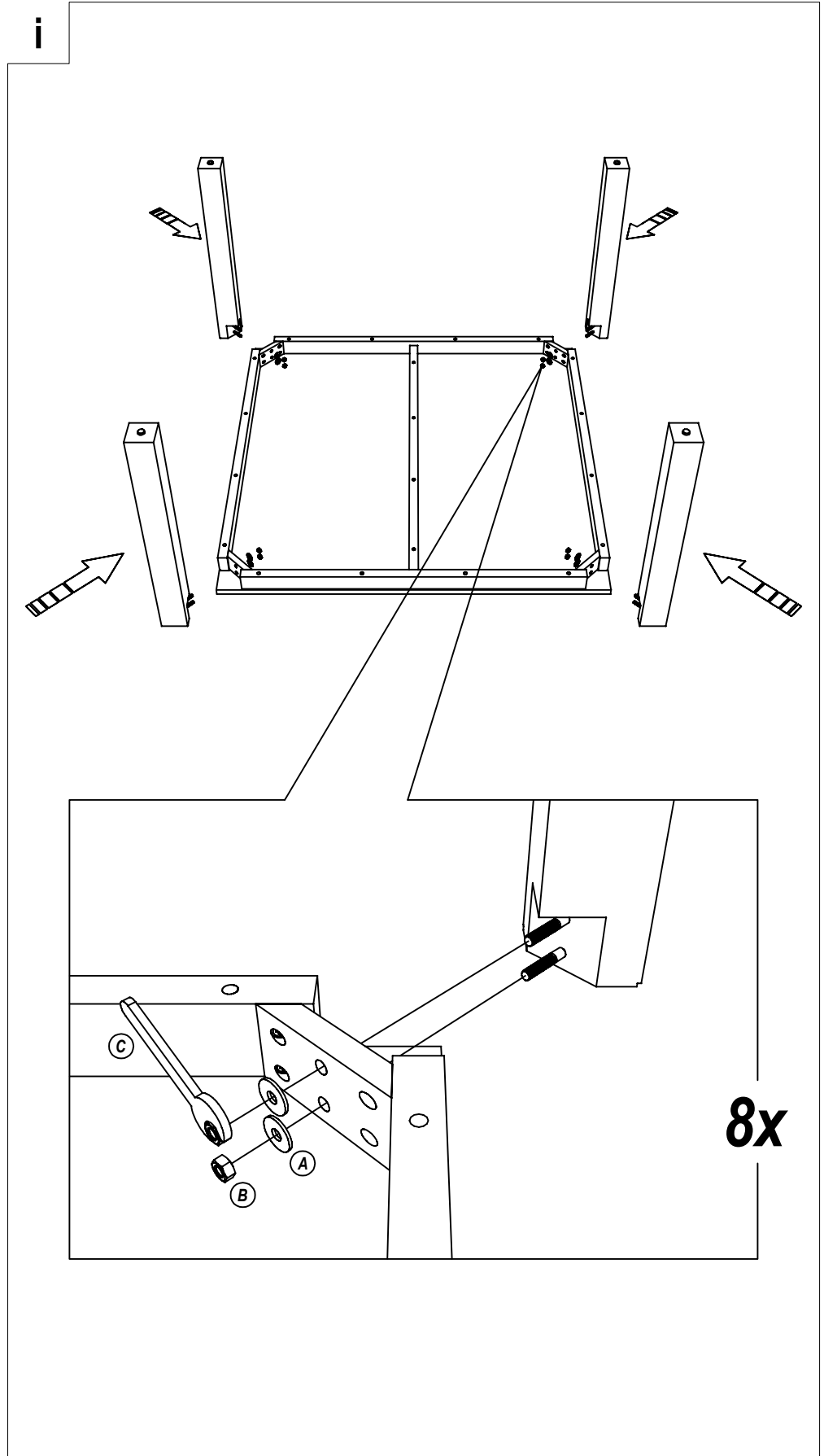

ii

