

DIN0059

Eden Teak Dining Table 90x90

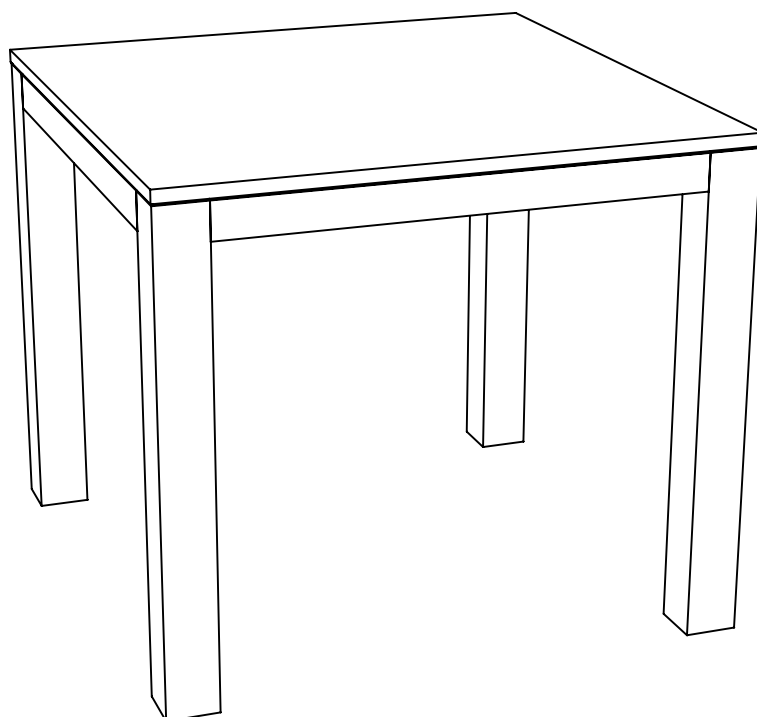

(FR) Notice de Montage -
Utilisation - Entretien

(IT) Istruzioni per il Montaggio,
l'Uso e la Manutenzione

(DE) Montage - Verwendung -
Wartungshandbuch

(ES) Instrucciones de Montaje,
Utilización y Mantenimiento

(EN) Assembly - Use -
Maintenance Manual

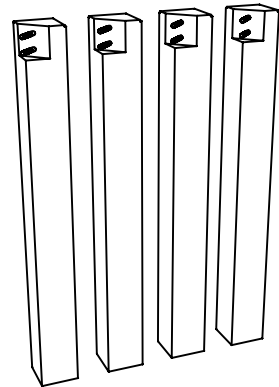
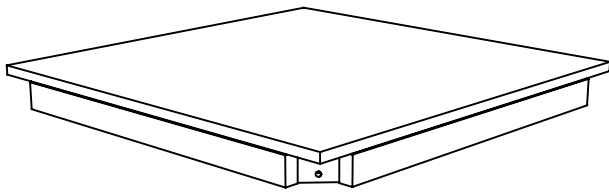

Plain Washer - M8

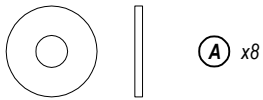

Spanner

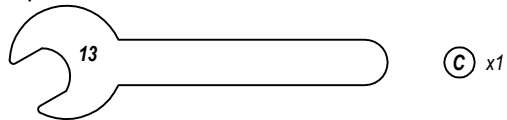

Hex Nut - M8

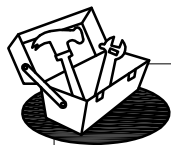
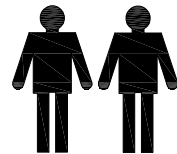
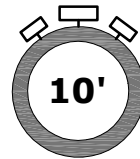
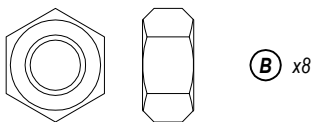

**NOT INCLUDED
NON FOURNIS**

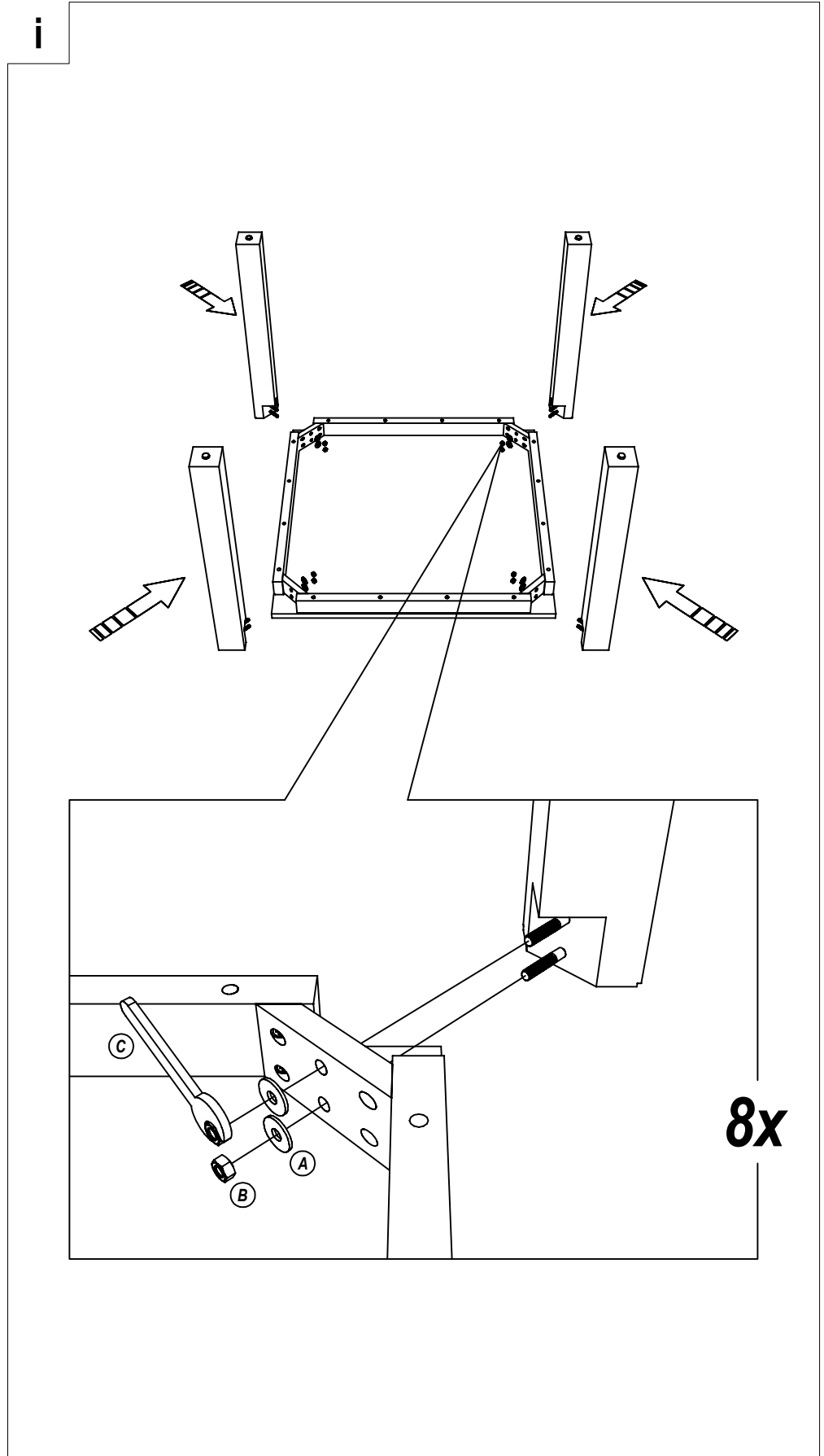
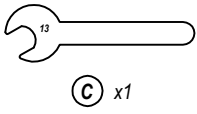
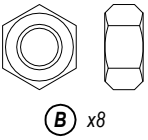
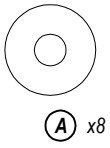

ii

