

BED0010

Taku Teak Bed 160 x 200

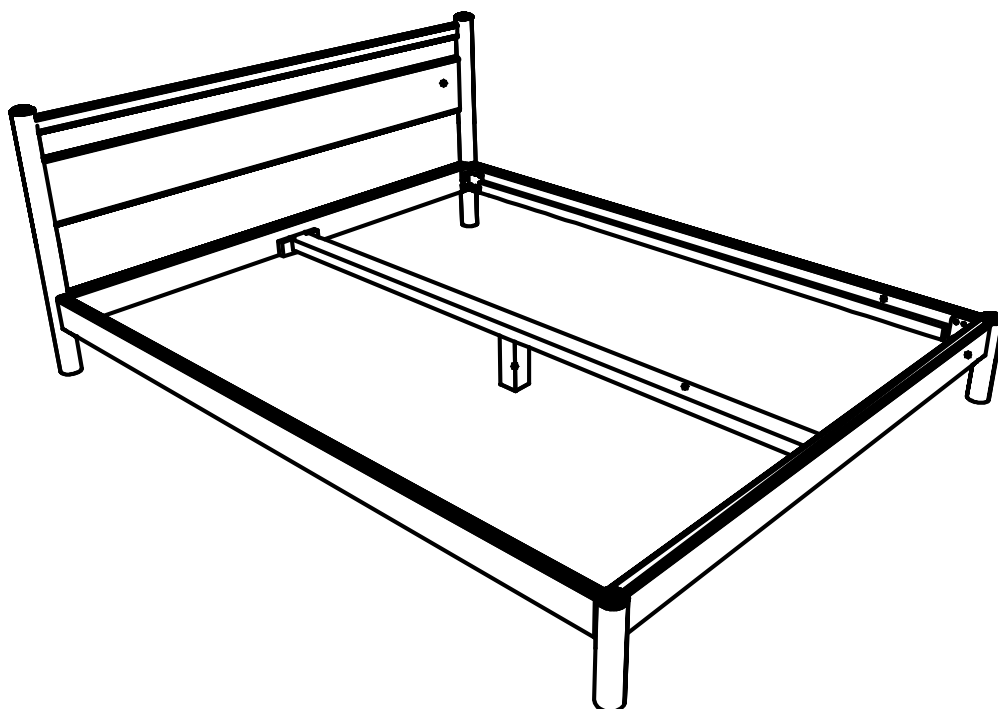

**(FR) Notice de Montage -
Utilisation - Entretien**

**(IT) Istruzioni per il Montaggio,
l'Uso e la Manutenzione**

**(DE) Montage - Verwendung -
Wartungshandbuch**

**(ES) Instrucciones de Montaje,
Utilización y Mantenimiento**

**(EN) Assembly - Use -
Maintenance Manual**

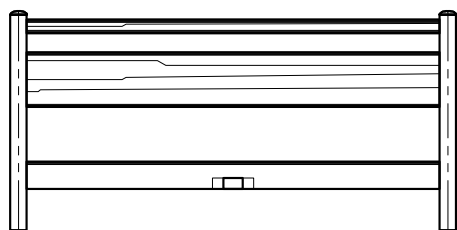
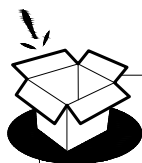

Headboard - 1 pcs

A

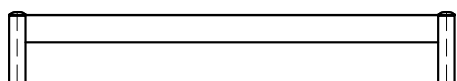

Footboard - 1 pcs

B

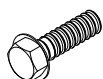

Hexagonal bolts - 8 pcs

F

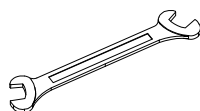

Wrench - 1 pcs

G

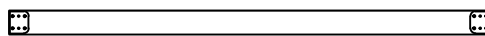

Side Rail - 2 pcs

C

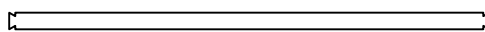

Center Rail - 1 pcs

D

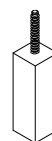

Extra Leg - 1 pcs

E

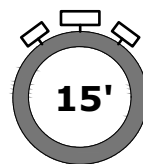

15'

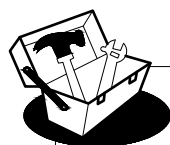
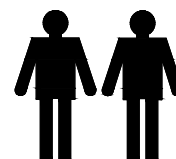

**NOT INCLUDED
NON FOURNIS**



Hexagonal bolts - 8 pcs

(F)

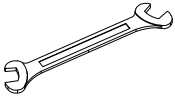

Wrench - 1 pcs

(G)

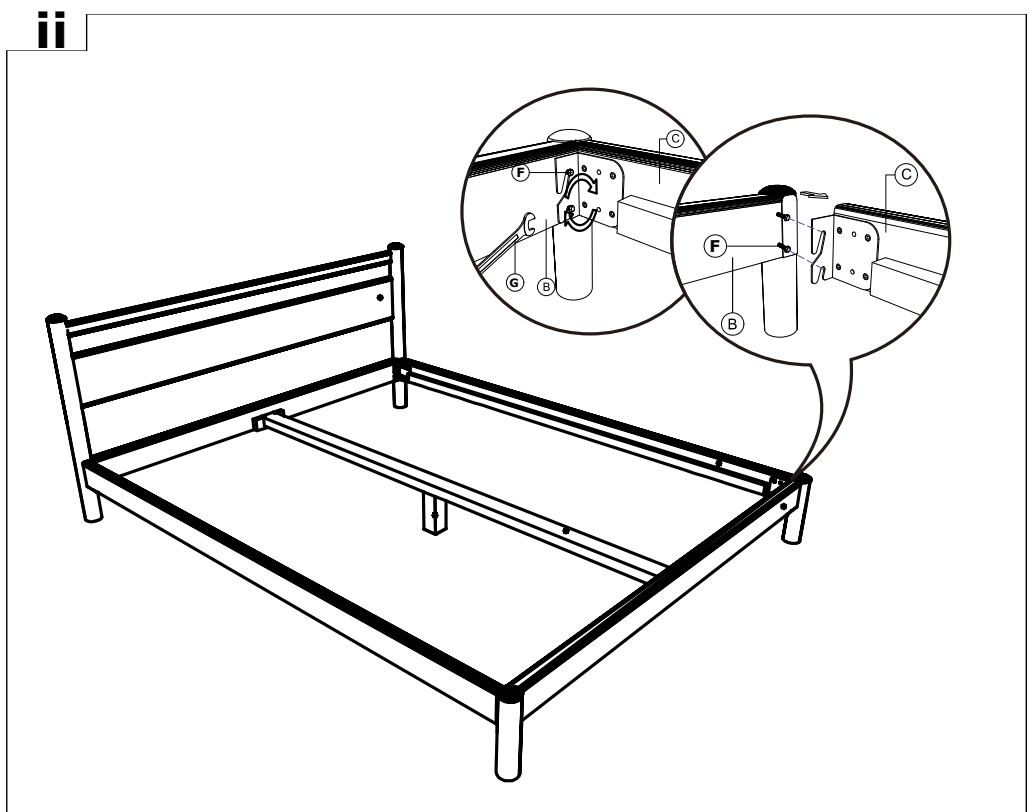
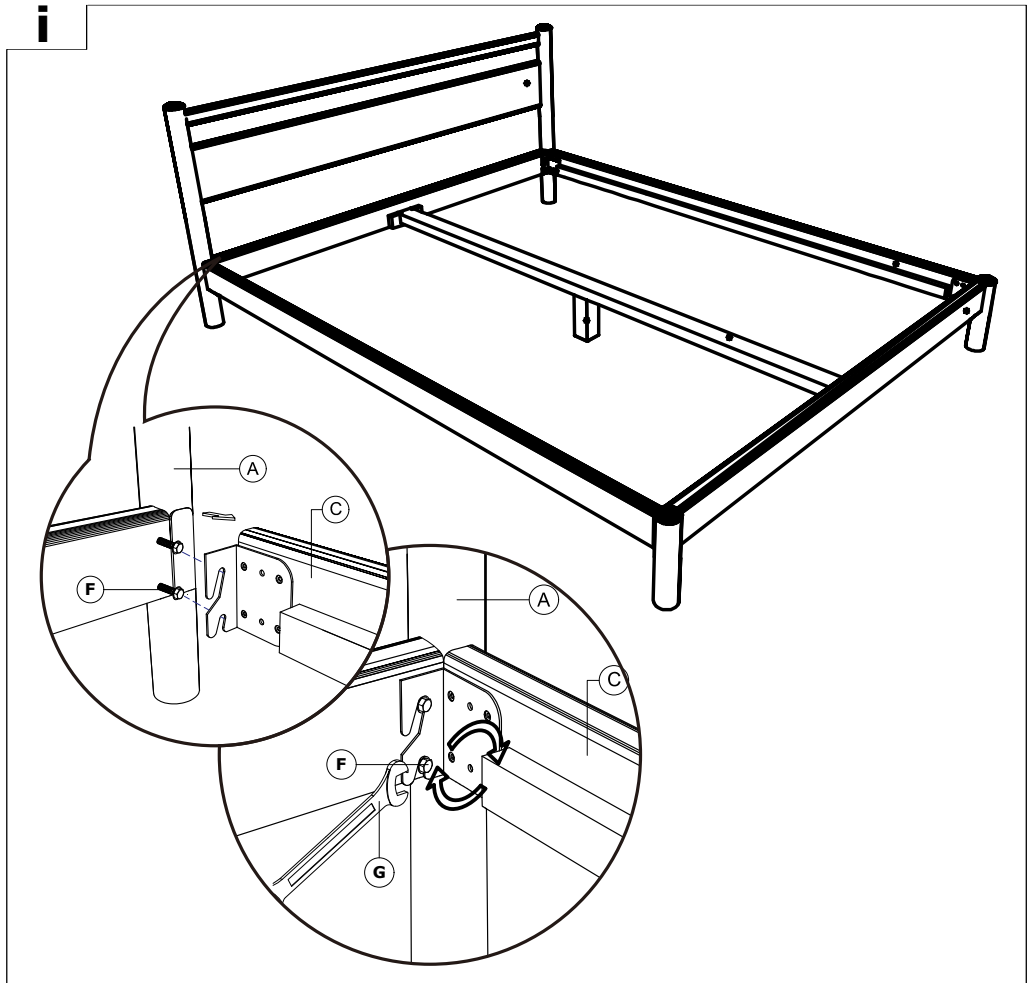

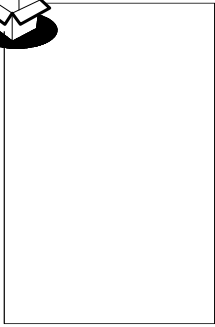

iii

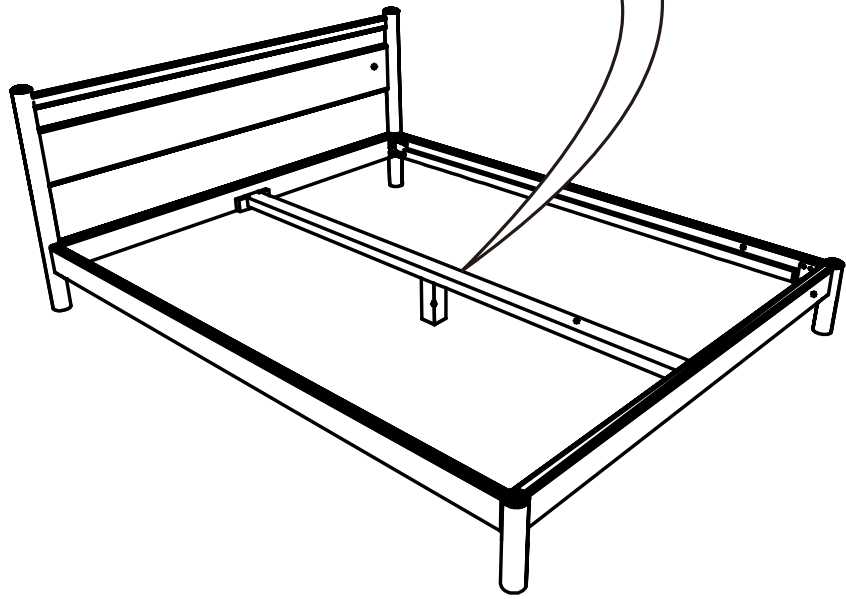
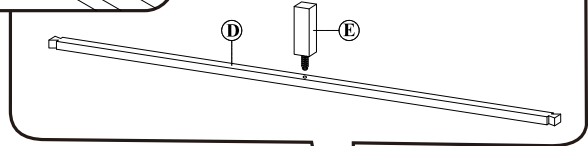
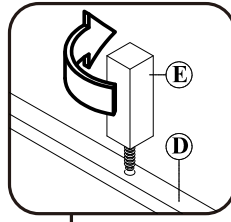

iv

