

# tikamoon

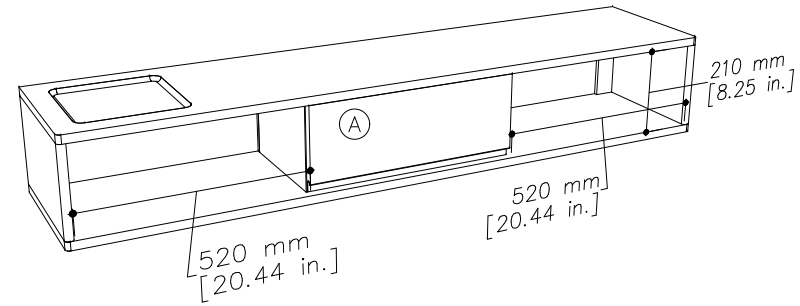

FLOOR

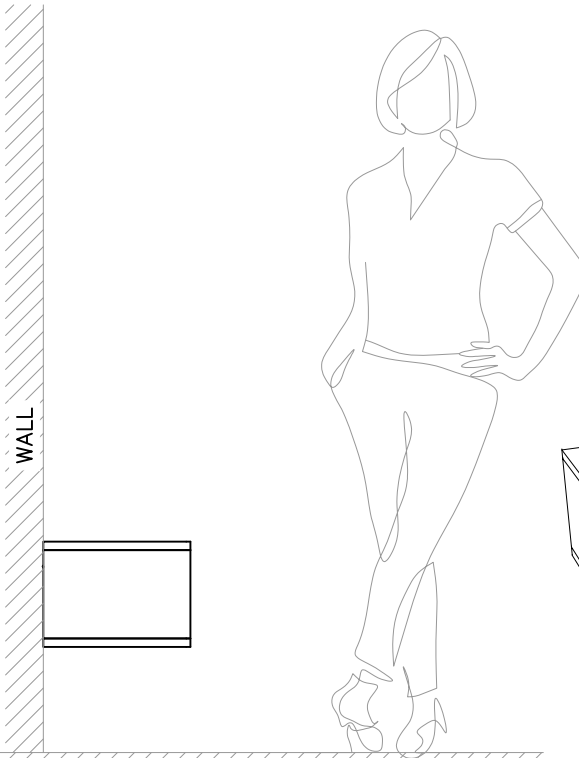
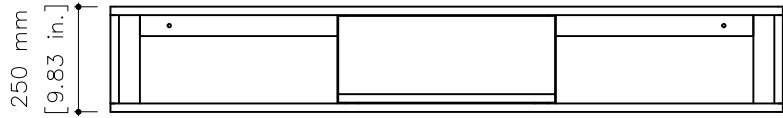
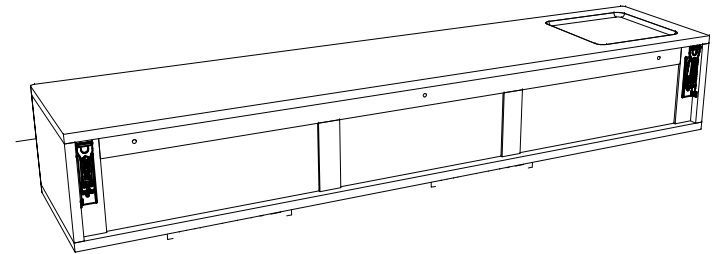
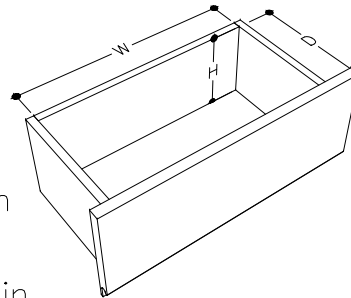
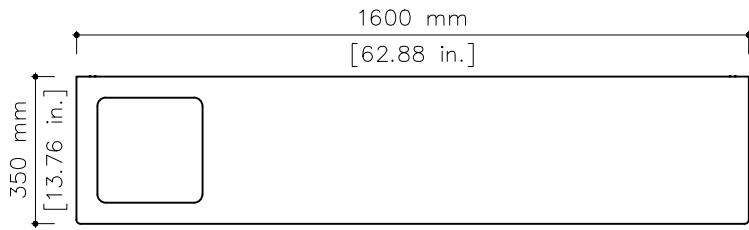
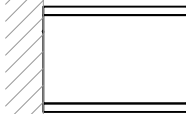

$W \times D \times H$   
 ① 425 x 230 x 155 mm  
 $W \times D \times H$   
 ① 16.73 x 9.05 x 6.10 in.

CC16

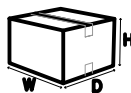

$W \times D \times H$ (mm)	$W \times D \times H$ (in.)
1640 x 290 x 390	64.56 x 11.41 x 15.35