

TVS0064

Gabrielle Mango TV Stand 160

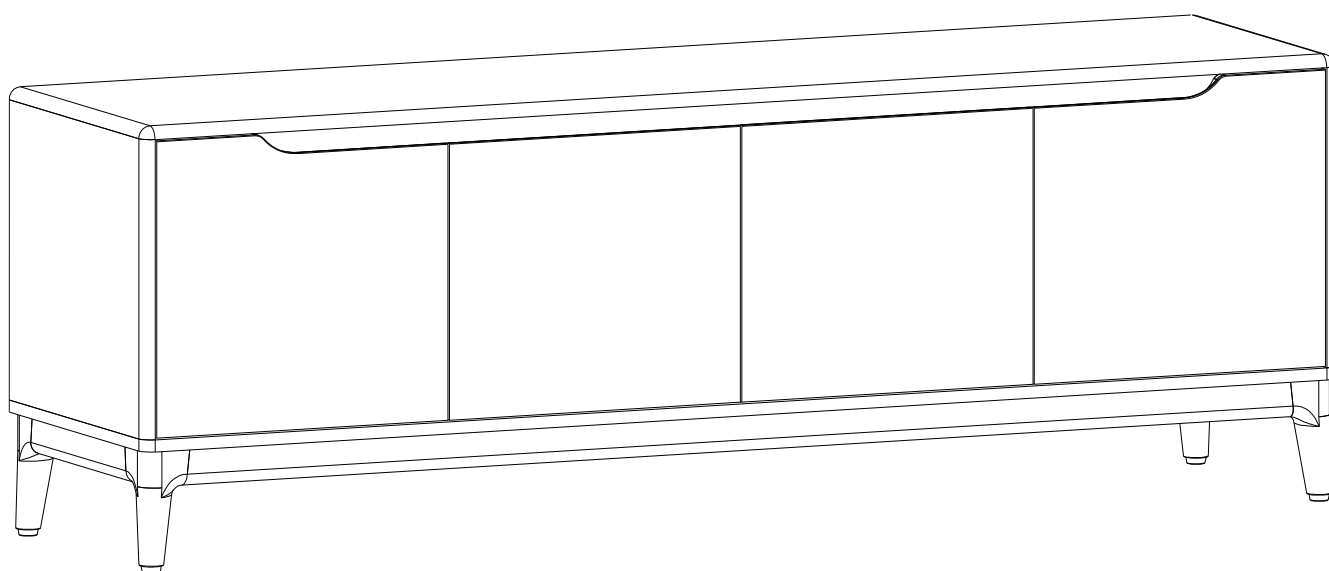

(FR) Notice de Montage -
Utilisation - Entretien

(IT) Istruzioni per il Montaggio,
l'Uso e la Manutenzione

(DE) Montage - Verwendung -
Wartungshandbuch

(ES) Instrucciones de Montaje,
Utilización y Mantenimiento

(EN) Assembly - Use -
Maintenance Manual

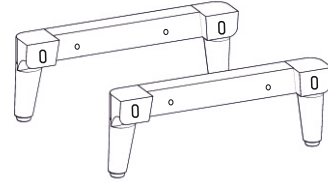
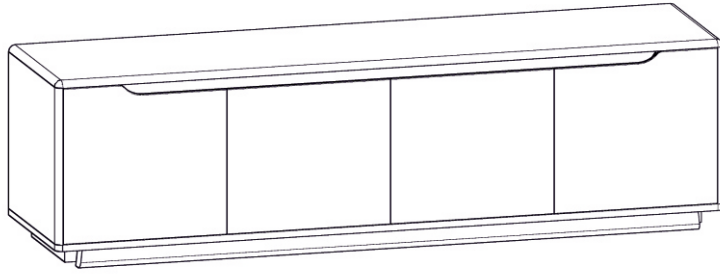
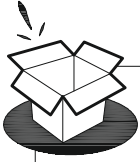

Bolt- 50x8 mm



A x4

Allen key- 5mm



C x1

Washer- 20x8 mm



B x4

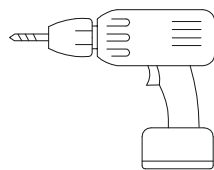
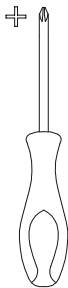
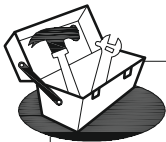
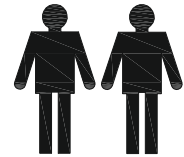
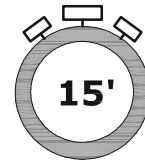

**NOT INCLUDED
NON FOURNIS**

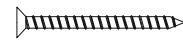

+

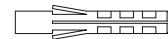

E x2

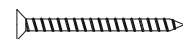

F x2



A x4



B x4



C x1

i

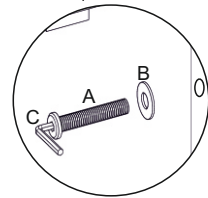
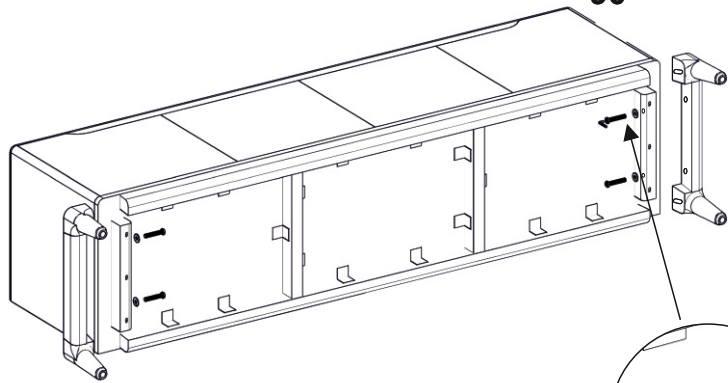
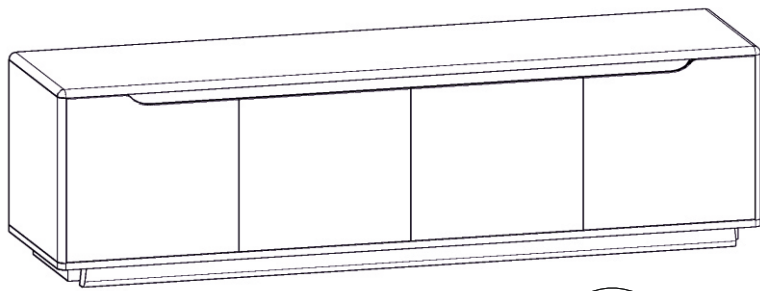

ii

