

# SOF0031

(SOF0030)

## Lugo Soil 10 Liver Longchair Arm L 150

combined with Lugo Arm Sofa R 3 seats

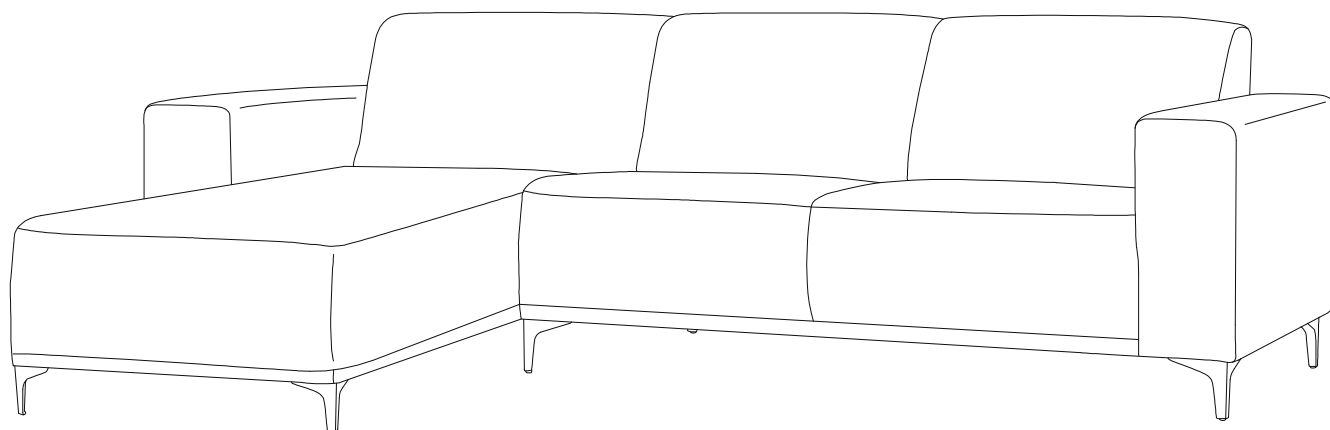

**(FR)** Notice de Montage -  
Utilisation - Entretien

**(IT)** Istruzioni per il Montaggio,  
l'Uso e la Manutenzione

**(DE)** Montage - Verwendung -  
Wartungshandbuch

**(ES)** Instrucciones de Montaje,  
Utilización y Mantenimiento

**(EN)** Assembly - Use -  
Maintenance Manual

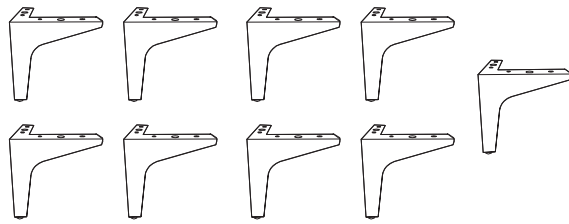
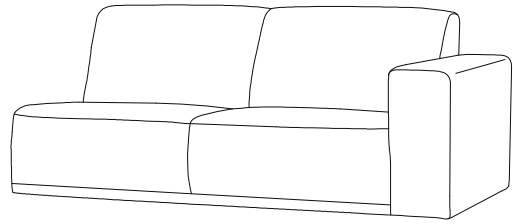
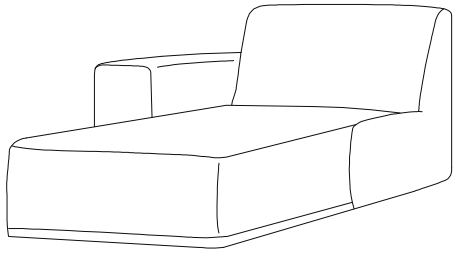
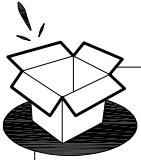

9 pcs.

Bolts - M6X25

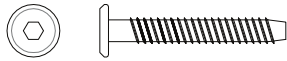

**A** 36pcs



**B** 1pc

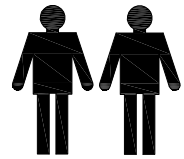
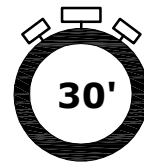

**NOT INCLUDED  
NON FOURNIS**



**A** x16



**B** x1

**i**

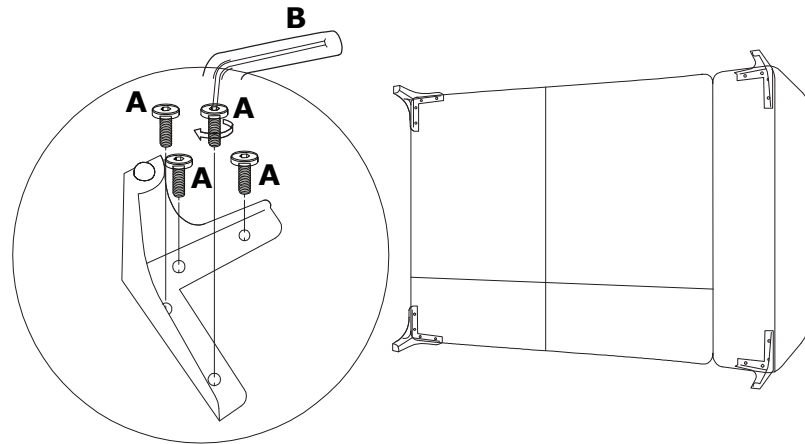
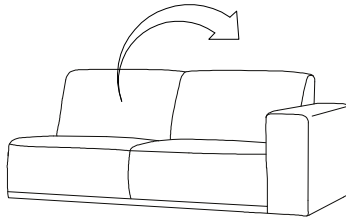

**A** x20



**B** x1

**ii**

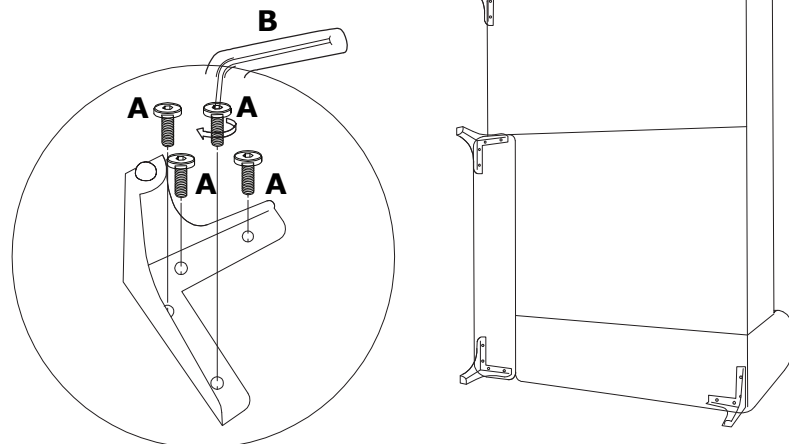
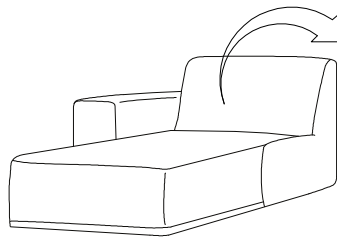

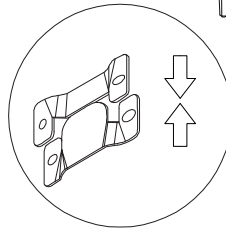
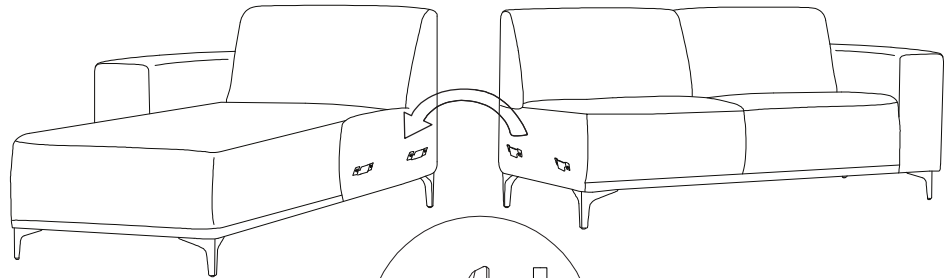

**FR**

Informations importantes

Lire attentivement

Suivre soigneusement chacune des étapes de ces instructions

**Conserver ces instructions pour une utilisation ultérieure****RECOMMANDATION PRÉVENTIVE:**

- Ne pas faire glisser les meubles.
- Des protections supplémentaires pour les pieds sont recommandées en fonction du revêtement de sol.
- Différents types de revêtements de sol tels que le bois dur et le marbre nécessitent différentes protections pour répondre à leurs besoins d'entretiens.
- Vos coussins de canapé et de méridienne changent naturellement de forme suivant la fréquence de leur utilisation. Il est donc naturel qu'ils s'affaissent avec le temps.
- Entretenir les tissus et enlever régulièrement les peluches augmentent la durabilité et l'aspect neuf du canapé.

**IT**

Avvertenze importanti

Da leggere con attenzione

Seguire attentamente ogni passaggio delle presenti istruzioni

**Conservare queste istruzioni per riferimento futuro****RACCOMANDAZIONE PREVENTIVA:**

- Sollevare il mobile senza trascinarlo.
- Si consiglia l'utilizzo di ulteriori protezioni per i piedi a seconda del tipo di pavimento.
- Vari tipi di pavimenti, come il legno massello o il marmo, richiedono protezioni diverse per soddisfare alle proprie esigenze di protezione.
- I cuscini del divano e della poltrona cambiano naturalmente forma nel tempo. È dunque naturale che affliscino nel tempo.
- La cura regolare del tessuto, eliminando pallini e pelucchi eventuali, aumenta la durata di vita e l'estetica del divano.

**DE**

Wichtige Information

Bitte sorgfältig lesen!

Befolgen Sie sorgfältig jeden Schritt dieser Anleitung

**Bewahren Sie diese Anleitung zur späteren Verwendung auf****VORBEUGENDE EMPFEHLUNG:**

- Verschieben Sie die Möbel nicht.
- Je nach Bodenbelag wird ein zusätzlicher Fußschutz empfohlen!
- Verschiedene Bodenbeläge wie Hartholz und Marmor erfordern unterschiedliche Schutzvorrichtungen, um ihren individuellen Anforderungen gerecht zu werden.
- Ihre Sofa- und Sesselkissen arbeiten hart und verändern im Laufe der Zeit auf natürliche Weise ihre Form. Sie verdienen ein wenig Verwöhnung von Zeit zu Zeit zur Zeit.
- Regelmäßige Pflege und Auflockern kann zu einem langlebigeren, jugendlicheren Sofa führen.

**ES**

Información importante

Leer atentamente

Siga cuidadosamente cada uno de los pasos de estas instrucciones

**Guarde estas instrucciones para un uso posterior****RECOMENDACIONES PREVENTIVAS:**

- No deslice los muebles.
- Dependiendo del revestimiento del suelo, se recomienda utilizar protectores de pies adicionales!
- Diferentes tipos de pisos, como madera dura y mármol, requieren diferentes fusibles para satisfacer sus necesidades únicas.
- Los cojines de su sofá y chaise lounge trabajan duro y cambian de forma naturalmente con el tiempo.
- El mantenimiento regular y la esponjosidad pueden dar lugar a un sofá más duradero y juvenil.

**EN**

Important information

Read carefully

Follow each step of instruction carefully

**Keep this information for further reference****PREVENTIVE RECOMMENDATION:**

- Do not slide the furniture.
- Additional foot protections are recommended depending on the floor covering!
- Various flooring types such as hardwood and marble require different protectors to suit their unique needs.
- Your couch and lounge chair cushions work hard and naturally change shape over time. They deserve a little pampering from time to time.
- Regular maintenance and fluffing can lead to a longer-lasting, more youthful sofa.