

# H01

## 170 Honorine teak TV unit

**A** LOW POSITION

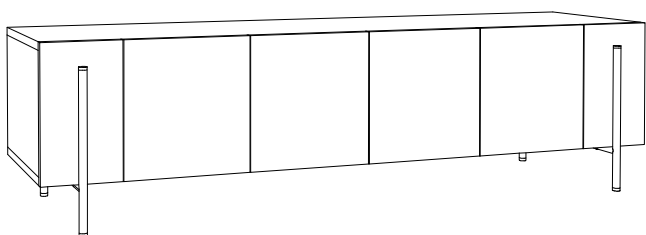

**B** HIGH POSITION

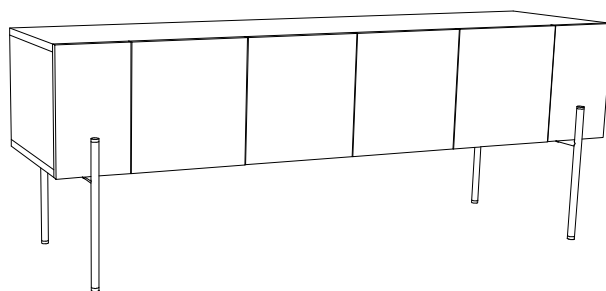

**FR** Notice de Montage -  
Utilisation - Entretien

**IT** Istruzioni per il Montaggio,  
l'Uso e la Manutenzione

**DE** Montage - Verwendung -  
Wartungshandbuch

**ES** Instrucciones de Montaje,  
Utilización y Mantenimiento

**EN** Assembly - Use -  
Maintenance Manual

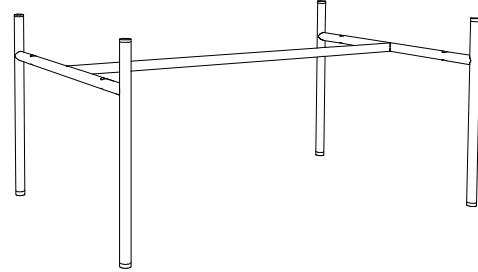
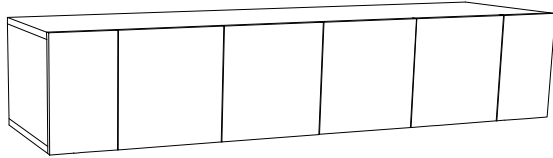
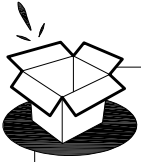

JCBC Bolt - 35 mm

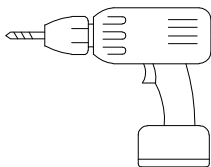
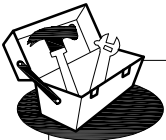
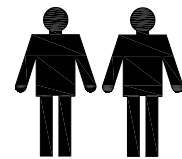
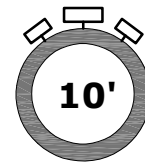
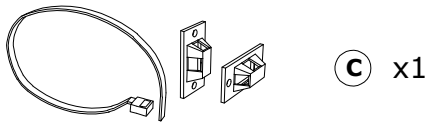
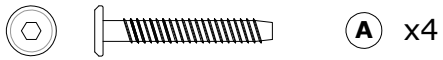

**NOT INCLUDED  
NON FOURNIS**

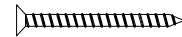

+



**D** x2

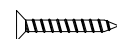

**E** x2



**A** x4



**B** x1

**i**

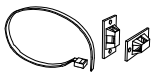
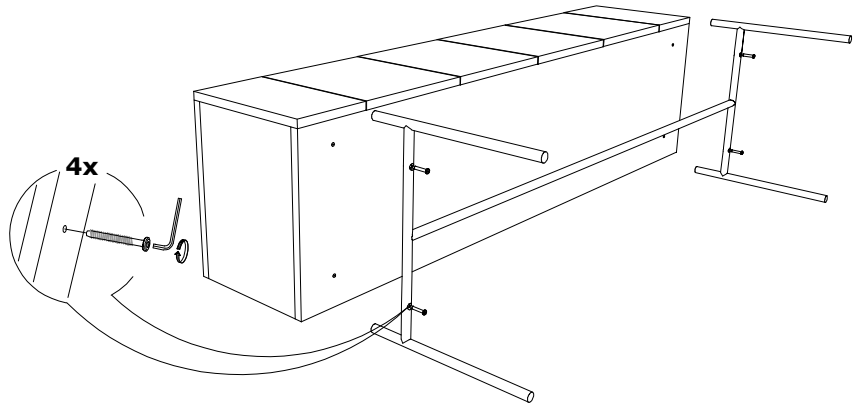
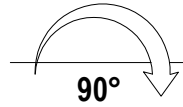
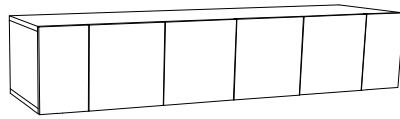

**C** x1

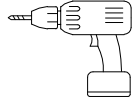

**ii**

**2x**

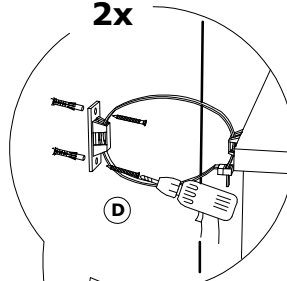

**D**

**2x**

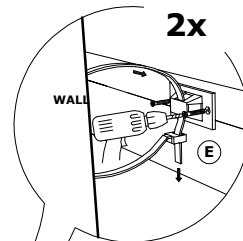

WALL

**E**

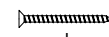
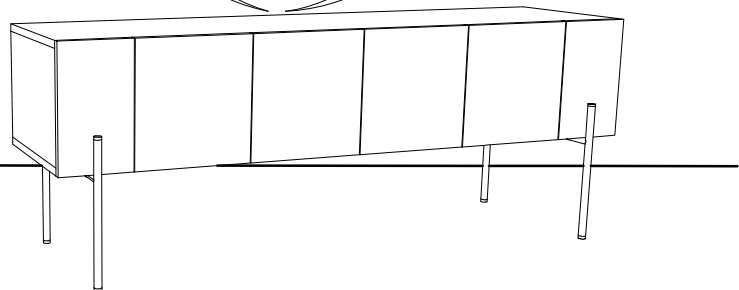

+



**D** x2



**E** x2

**FR**

Information importante  
Lire attentivement  
Suivre soigneusement chacune des étapes de ces instructions

## Conserver ces instructions pour une utilisation ultérieure

### ATTENTION

Pour éviter tout risque de basculement, ce meuble doit être solidement fixé au mur.  
Vérifier la pertinence et la solidité du mur afin de s'assurer que le mur puisse supporter la charge du meuble et résister aux forces générées au niveau des fixations. Un montage mal effectué peut provoquer la chute du meuble et des blessures graves sur les personnes.  
En cas de doute concernant l'installation, contactez un professionnel.

\* Utiliser des vis, rondelles et chevilles adaptées au type de matériau de votre mur. **Celles-ci ne sont pas incluses.**  
Pour obtenir des conseils sur les vis et ferrures adaptées à votre mur, adressez-vous à un revendeur spécialisé.

**IT**

Avvertenze importanti  
Da leggere con attenzione  
Seguire attentamente ogni passaggio delle presenti istruzioni

## Conservare le presenti istruzioni per successivi utilizzi

### ATTENZIONE

Questo mobile deve essere saldamente fissato a parete al fine di prevenire il rischio ribaltamento.  
Verificare l'adeguatezza e la solidità della parete per assicurarsi che questa sia in grado di sopportare il peso del mobile e resistere a sforzo e pressione degli elementi di fissaggio.  
Qualora il mobile dovesse essere installato in maniera non corretta, potrebbe ribaltarsi provocando eventuali gravi infortuni alle persone.  
In caso di dubbi sul montaggio, si raccomanda di rivolgersi ad un professionista.

\* Utilizzare viti, rondelle e tasselli adeguati al tipo di materiale della parete. **Tali elementi non sono inclusi.**  
Per ricevere consigli circa viti e raccordi adatti alla parete alla quale verrà fissato il mobile, vi suggeriamo di rivolgervi ad un rivenditore specializzato.

**DE**

Wichtige Information  
Bitte sorgfältig lesen!  
Befolgen Sie sorgfältig jeden Schritt dieser Anleitung

## Bewahren Sie diese Anleitung zur späteren Verwendung auf

### ACHTUNG

Damit dieses Möbelstück nicht umkippen kann, muss es fest an der Wand montiert werden.  
Prüfen Sie die Beschaffenheit und Stabilität der Wand, um sicherzustellen, dass sie das Gewicht des Möbelstücks halten kann und den auf die Befestigungsvorrichtungen wirkenden Kräften widersteht.  
Eine falsche Montage kann zum Umfallen des Möbelstücks und zu schweren Verletzungen von Personen führen.  
Wenden Sie sich an eine Fachkraft, falls Sie bezüglich der Montage Zweifel haben.

\* Verwenden Sie Schrauben, Unterlegscheiben und Dübel, die für das Material Ihrer Wand geeignet sind. **Dieses Zubehör ist nicht enthalten.**  
Wenden Sie sich an einen Fachhändler, um zu erfahren, welche Schrauben und Beschläge für Ihre Wand geeignet sind.

**ES**

Información importante  
Leer atentamente  
Siga cuidadosamente cada uno de los pasos de estas instrucciones

## Guarde estas instrucciones para un uso posterior

### ATENCIÓN

To avoid any risk of toppling, this furniture para evitar cualquier riesgo de vuelco, este mueble debe estar firmemente fijado a la pared.  
Compruebe la idoneidad y la solidez de la pared para garantizar que esta pueda soportar la carga del mueble y resistir las fuerzas generadas a nivel de los elementos de fijación. Un montaje incorrecto puede provocar la caída del mueble y, así, graves lesiones a las personas.  
En caso de duda sobre la instalación, póngase en contacto con un profesional.

\* Utilice tornillos, arandelas y tacos adaptados al tipo de material de su pared. **Estos no están incluidos.**  
Para obtener información sobre qué tornillos y herrajes son adecuados para su pared, póngase en contacto con un distribuidor especializado.

**EN**

Important information  
Read carefully  
Follow each step of instruction carefully

## Keep this information for further reference

### WARNING

To avoid any risk of toppling, this furniture item / object must be securely attached to the wall.  
Check the suitability and the strength of the wall to ensure that the wall can bear the load of the furniture / object and withstand the forces put on the securing elements. Improper installation can result in the furniture / object falling and cause serious injuries to people.  
In case of a doubt regarding the installation, ask for advice from a professional.

\* Use screws, washers and plugs suited to the type of material of your wall. **These are not included.**  
To obtain advice on the screws and fittings suited to your wall, ask your local specialized dealer.