

DIN0016

Oak Dining Table 1500 x 750 x 1050

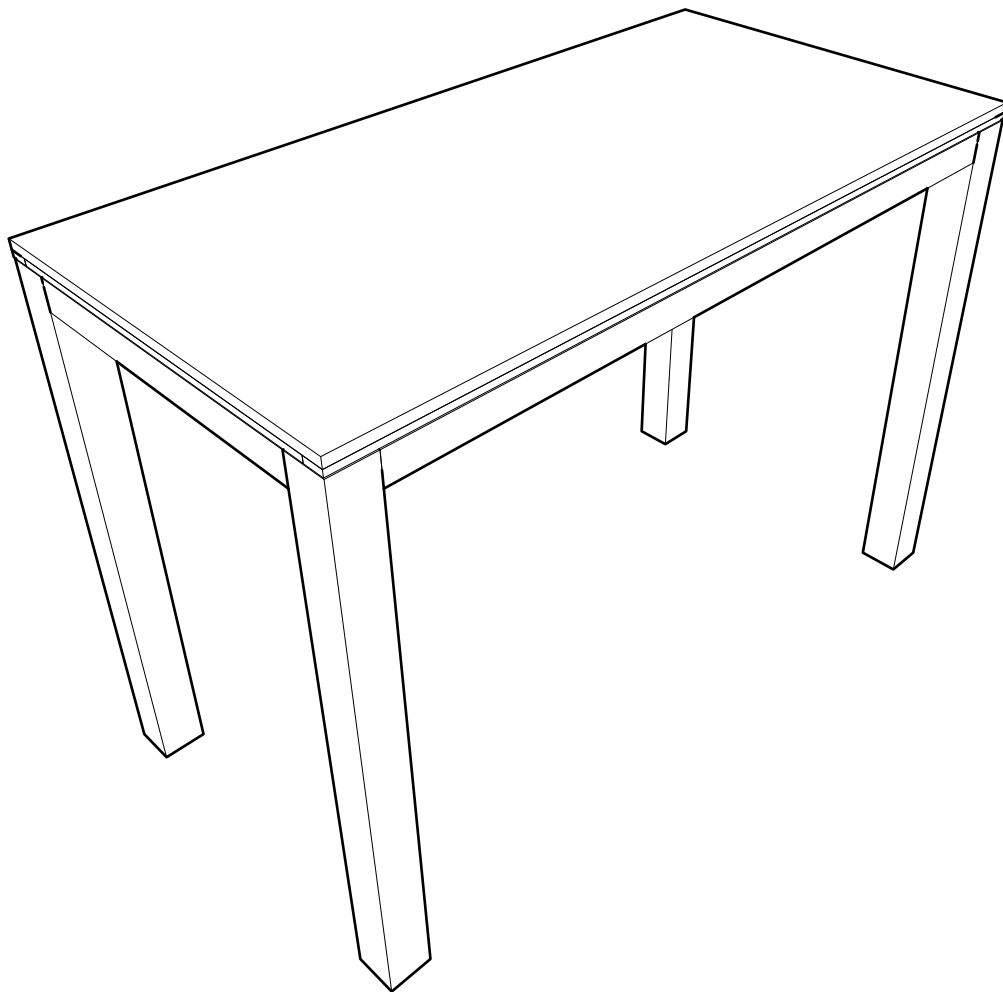

**(FR) Notice de Montage -
Utilisation - Entretien**

**(IT) Istruzioni per il Montaggio,
l'Uso e la Manutenzione**

**(DE) Montage - Verwendung -
Wartungshandbuch**

**(ES) Instrucciones de Montaje,
Utilización y Mantenimiento**

**(EN) Assembly - Use -
Maintenance Manual**

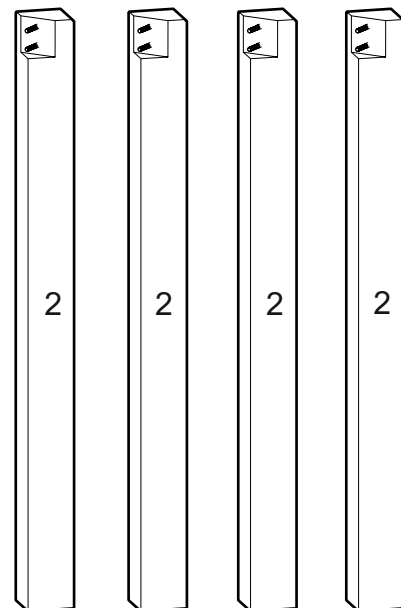
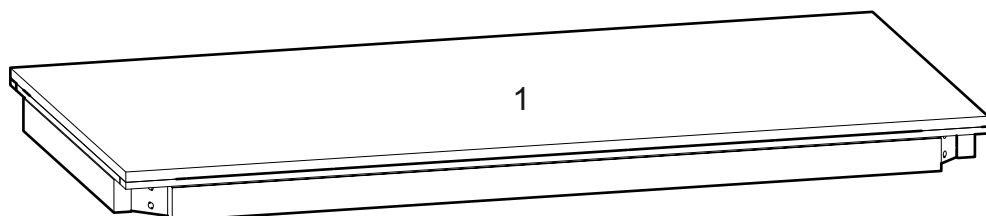
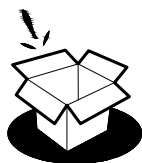

Washer - M8

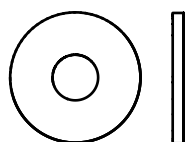

A x8

Internal screw - M8

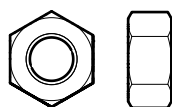

B x8

№13

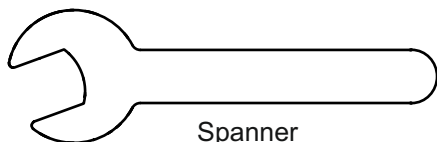

Spanner

C x1

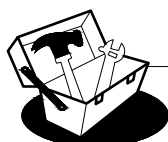
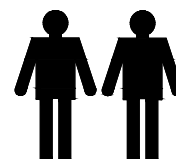
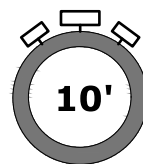

**NOT INCLUDED
NON FOURNIS**



A x8



B x8

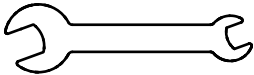

№13 **C** x1



**NOT INCLUDED
NON FOURNIS**

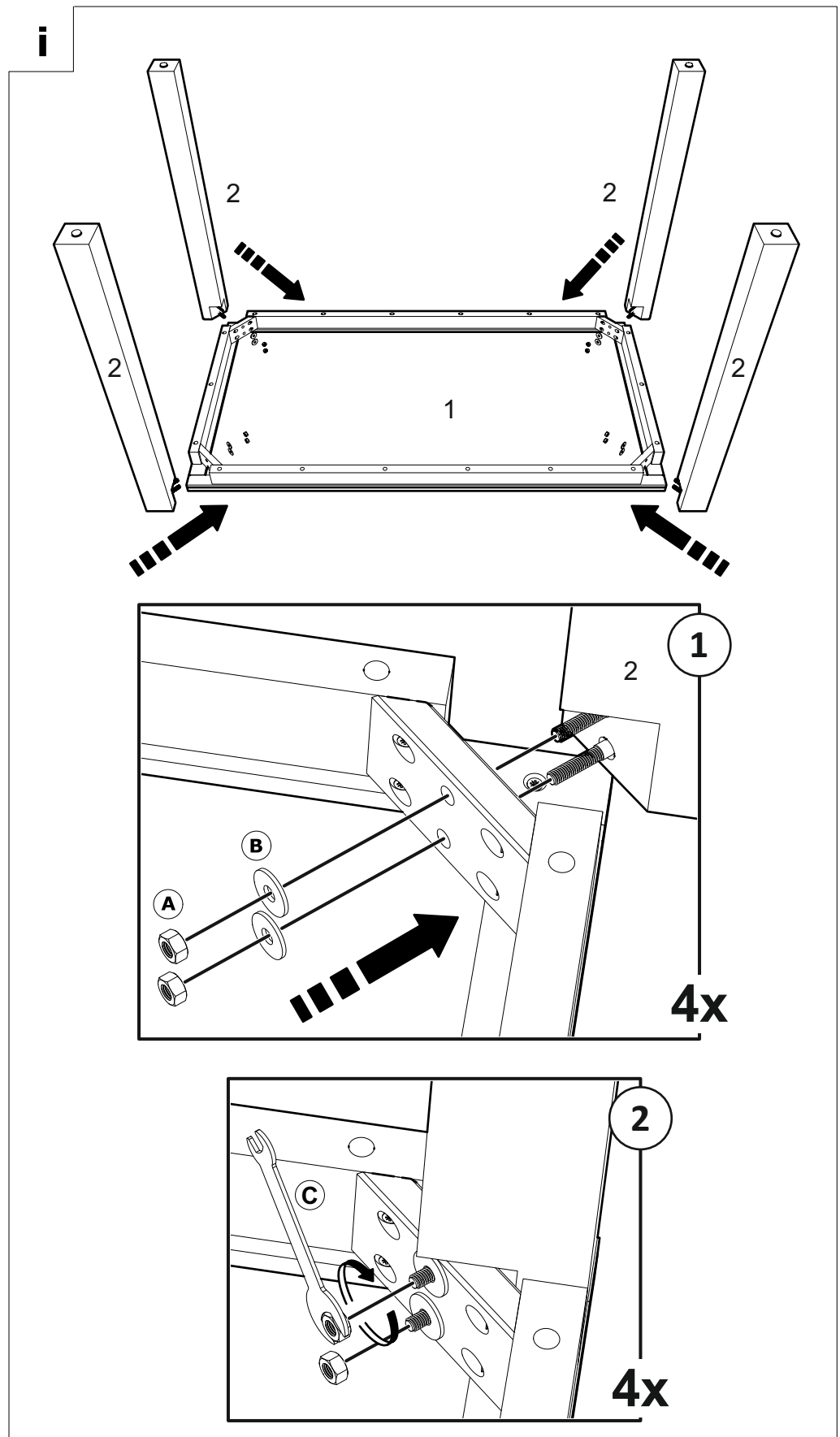

ii

