

**DIN0009**

**MANGO DINING TABLE**

---

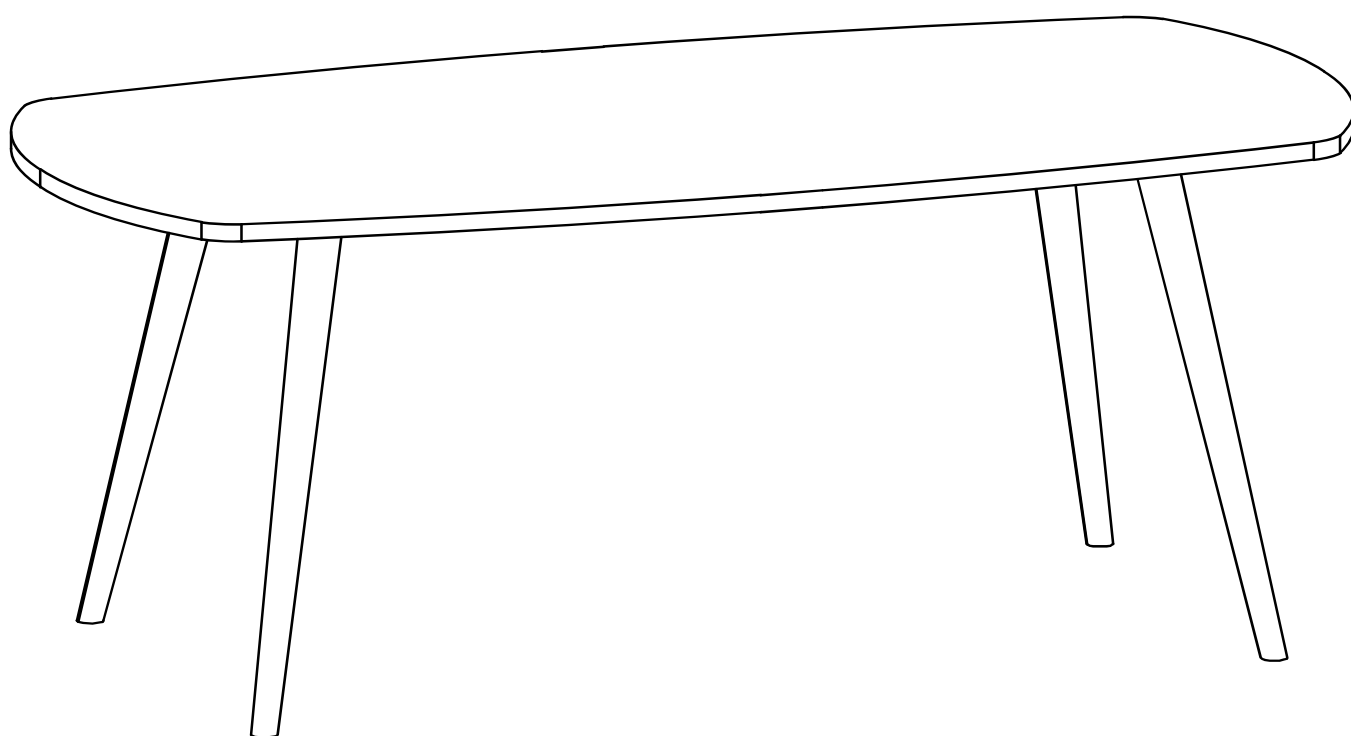

---

**(FR)** Notice de Montage -  
Utilisation - Entretien

**(IT)** Istruzioni per il Montaggio,  
l'Uso e la Manutenzione

**(DE)** Montage - Verwendung -  
Wartungshandbuch

**(ES)** Instrucciones de Montaje,  
Utilización y Mantenimiento

**(EN)** Assembly - Use -  
Maintenance Manual

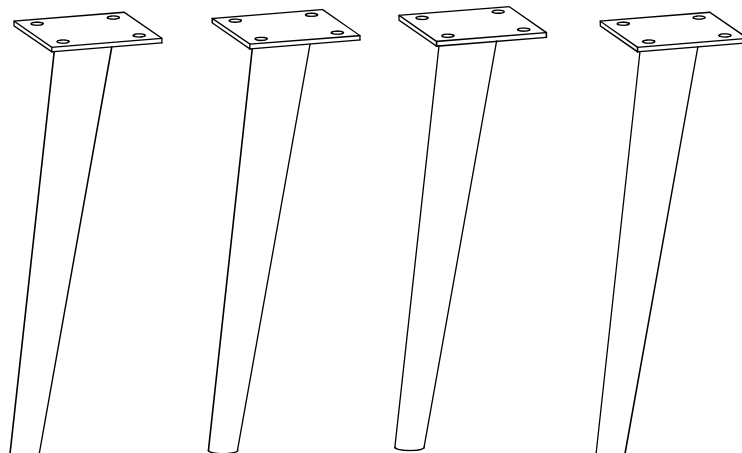
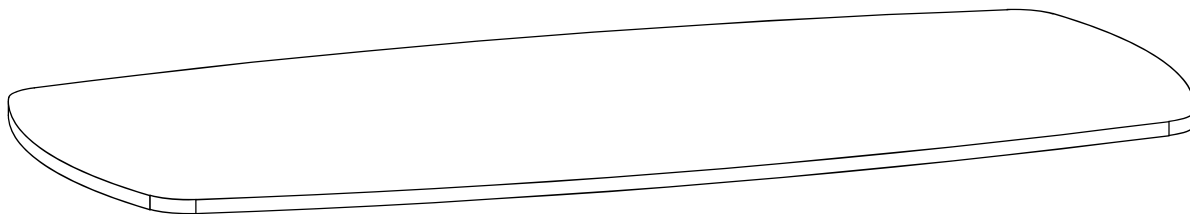
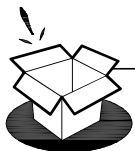

JCB Bolt- 20x8mm

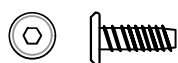

**A** x16



**B** x16

Allen Key-5mm



**C** x1

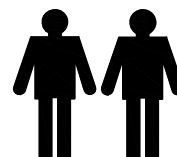
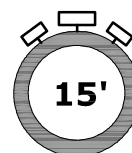



**A** x16



**B** x16



**C** x1

