

**COF0067**

# Teo Teak Coffee Table

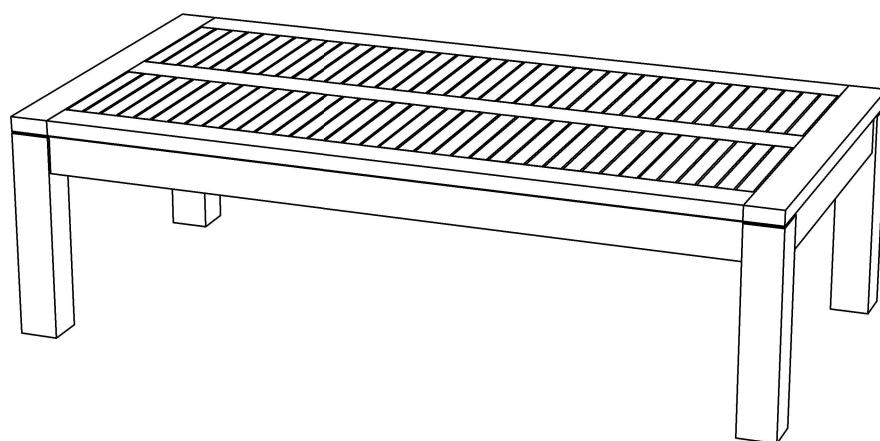

**FR** Notice de Montage -  
Utilisation - Entretien

**IT** Istruzioni per il Montaggio,  
l'Uso e la Manutenzione

**DE** Montage - Verwendung -  
Wartungshandbuch

**ES** Instrucciones de Montaje,  
Utilización y Mantenimiento

**EN** Assembly - Use -  
Maintenance Manual

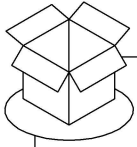

**INCLUDED**

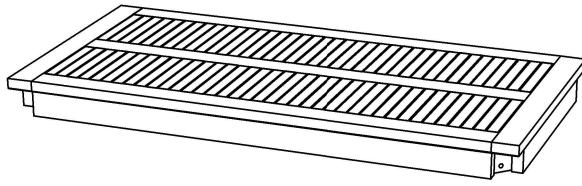

Top Panel - 1 pcs



Leg - 4 pcs

Flat Washer - M8

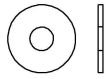

**A** 8 pcs

Hex Nut - M8



**B** 8 pcs

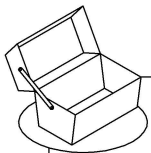
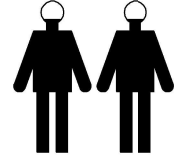
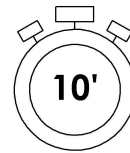

**TOOLS**



**NOT INCLUDED**



A 8 pcs



B 8 pcs

